

The logo for PTZ OPTICS features the letters 'P', 'T', and 'Z' each enclosed within a stylized camera aperture icon. The word 'OPTICS' is written in a clean, sans-serif font to the right of these icons.

**PTZ OPTICS**

**General Quickstart Guide and Resource Locations**

## Welcome to PTZOptics

The entire PTZOptics family wants to thank you for your purchase of one of our products.

We pride ourselves on offering a wide array of solutions with a focus on the right features to get your job done.

---

If you ever have a problem with your PTZOptics camera, don't hesitate to reach out to our amazing support team.

[support@ptzoptics.com](mailto:support@ptzoptics.com)  
<http://help.ptzoptics.com>

---

The following guide has been assembled to help you use your new PTZOptics camera how you want, as quickly as possible.

In the table of contents on the next page, you'll see different ways you can interact with your PTZOptics camera.

If you still have questions after reading through this guide, our always up-to-date user manual can be downloaded from our website.

<https://ptzoptics.com/resource-library/>

## Connecting Your Camera for the First Time

Your new camera has many options for connecting, powering, controlling, and streaming. This Quick Start Guide will help you understand how to use each of these different options.

1. Refer to the **Table of Contents** on the following page to find the various options available for your camera.
2. Read the instructions for the specific aspect of your camera that you want to use.
3. Refer to the page following the Table of Contents for an illustration of the back plate of your camera. Use this illustration to help determine which aspect of the camera you would like to use.
4. If you are having trouble using your camera, please refer to the **Troubleshooting** section of this guide.

### PTZOptics Quick Start Guide Video

We have videos to help you set up and use your camera. Scan the QR code below to visit our YouTube page:

<https://bit.ly/ptzsetup>



## Table of Contents

PTZOptics EPTZ-ZCAM Camera Back Connection	4
SDI Connection	5
IP Connection	6
3.5mm Audio Connection	7
RTSP Streaming	8
RTMP Streaming	9
NDI® HX Streaming and Control	10
RS-485 Control	11
IP Control	12
Power Your Camera	13
Web UI	14
Find Software to Get Started	15
User Manual / General Resources	16
Troubleshooting	17

## PTZOptics EPTZ-ZCAM Camera Back Connection

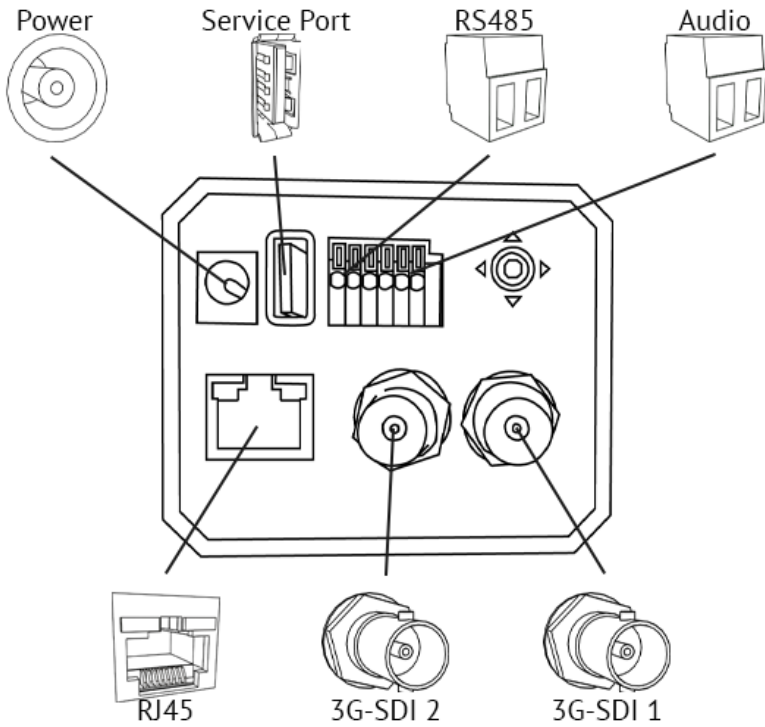

## SDI Connection

Your camera comes with a 3rd Generation Serial Digital Interface (3G-SDI) connection. Connect one end of the SDI cable into the SDI port of your camera (Cable not included). Connect the other end of the cable to the device of your choice.

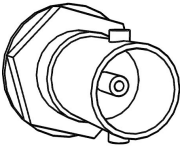

To achieve best results, we recommend using a 3G-SDI cable or better. 3G-SDI cables can be run up to 300 feet (91 Meters)

1. Connect the male end of the SDI cable to the female connector on the camera.
2. Connect the other male end of the SDI cable to the female connector on the device of your choice.
3. Power on the camera.
4. Select the camera within your device of choice.

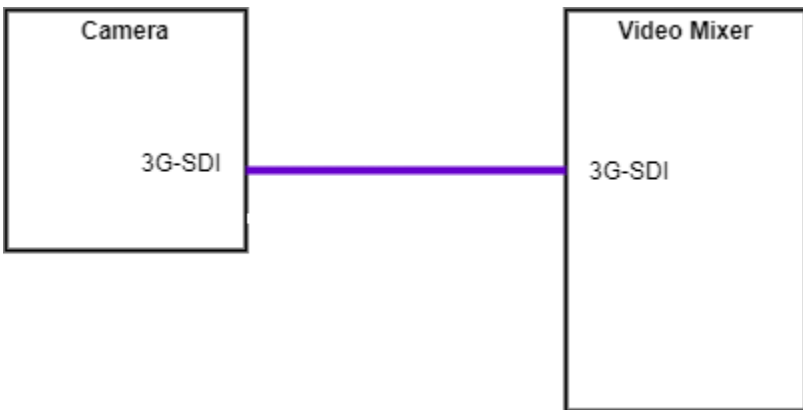

## IP Connection

Your PTZOptics ZCAM camera is set to 192.168.100.99 by default. You will initially need to navigate to //192.168.100.99 through a web browser to access your camera.

You can also change your camera's network address, using our IP Address Setting Tool:

<http://ptzoptics.com/setup>

Once you download and open the upgrade tool, click on the 'Search' Function on the opening tab to find your camera.

You can also set the camera to utilize DHCP by holding down on the left D-Pad for 5 seconds. Which means it will receive an IP address from a DHCP server, typically your router.

### 3.5mm Audio Connection

Your camera comes with a 3.5mm audio connection, which allows you to embed audio on your video stream.

Connect a 3.5mm audio cable (not included) to the 3.5mm audio in port of your camera. Connect the other end of the cable to the device of your choice.

Note: The 3.5mm audio connection requires Line Level audio in order to function.

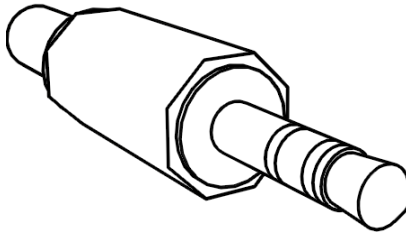



## RTSP Streaming

Your camera is able to send an RTSP stream for viewing video through a LAN or Internet connection.

Using VLC or another RTSP enabled video program, type the following string into your network streaming section:

**Stream 1 (HD):**

rtsp://[IP ADDRESS]:554/1

**Stream 2 (SD):**

rtsp://[IP ADDRESS]:554/2

If you do not know the IP address of your camera, refer to the **IP Connection** section of this guide.

## RTMP Streaming

Your camera can send two RTMP(S) streams. To use your camera with an RTMP stream, you will need an RTMP MRL, which you receive from a CDN or from the social network to which you want to stream.

Once you have the RTMP MRL, type the IP Address of your camera into your web browser. You will be prompted for the credentials for the camera Web UI. These credentials are admin/admin by default.

Once you are logged into the Web UI of your camera, navigate to the Network section.

In the network section, there is a section titled **RTMP(S) Settings**. This is where you will enter the RTMP MRL you received from the CDN or social network.

Make sure that you turn your RTMP stream “On” by selecting the appropriate radio button.

Reboot your camera to start the RTMP(S) stream.

### RTMP Section of the Web UI:



**RTMP(S) Settings**

First stream:  On  Off  Video  Audio

MRL:

Second stream:  On  Off  Video  Audio

MRL:

## NDI®|HX Streaming and Control

Your camera is capable of running NDI®|HX. NDI®|HX allows for efficient distribution of audio and video on a LAN.

If your camera has the NDI®|HX logo, then NDI®|HX is already enabled. If your camera does not have the NDI®|HX logo, contact your local PTZOptics reseller to purchase a license.

To get started with NDI®|HX, download and install the NDI®|HX tools:

<https://ndi.tv/tools/#download-tools>

Once the NDI®|HX tools are installed, open Studio Monitor. Studio Monitor allows you to view all NDI®|HX feeds available on your LAN.

Right-click on the Studio Monitor screen. Your camera should be listed.

NDI®|HX cameras need to be connected to a router with IGMP snooping level 2 or 3 running as a service.

If you need help connecting to your NDI®|HX camera, contact our support department: [support@ptzoptics.com](mailto:support@ptzoptics.com)

## RS-485 Control

Your camera has a RS-485 connector. This can be used for serial control of your camera. To use serial control with your camera, connect one end of your serial cable (not included) to the camera and connect the other end to the device of your choice.

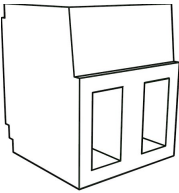

Your camera supports PELCO-D and VISCA control. Please refer to your user manual for a list of supported commands.

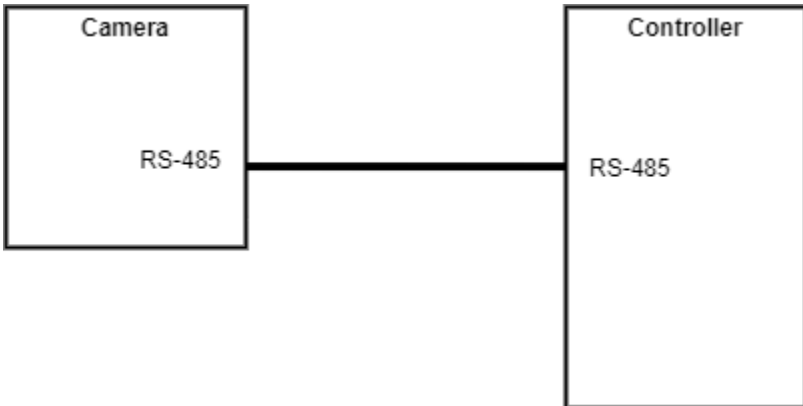

## IP Control

You can control all functions of your camera through Internet Protocol (IP). Your camera must be connected to an active LAN or Internet connection to be controlled through IP. Please see the **IP Connection** section of this guide for more information.

## Web UI

You can control the camera through the Web UI. Please see the **Web UI** section of this guide for more information.

## Studio Monitor

If you have NDI®|HX installed on your camera, you can use NDI®|HX Studio Monitor for basic pan, tilt, zoom, and focus control. Please see the **NDI Streaming and Control** section of this guide for more information.

## VISCA over IP

Your camera can be controlled through PTZOptics VISCA over IP. Please refer to your manual.

## Http commands (cgi/bin)

Your camera can accept HTTP CGI/BIN commands. Please refer to your manual.

## IP Controller

PTZOptics sells IP controller joysticks to give you more control over your camera.

## Power Your Camera

Your camera can be powered through DC power (with the included adapter) OR Power over Ethernet (with a switch or router rated for 802.3af)

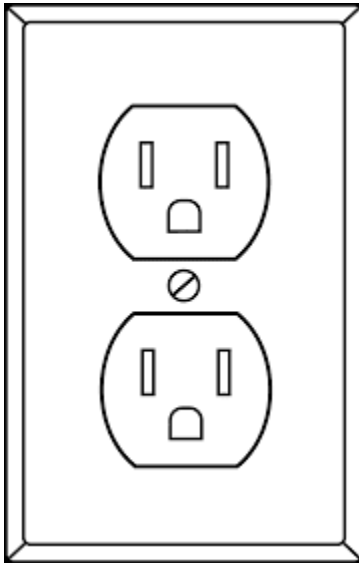

If using SDI for video you need to provide power via the DC input.

If using RTSP/ RTMP / NDI|HX for video you can use PoE power or DC input.

If you want to power the camera using PoE and use SDI outputs for video you will need a PoE Splitter.

## Web UI

You can access the Web UI of your camera by entering the camera's IP address into your web browser. The default credentials are admin/admin.

The left panel of the Web UI includes links to control various aspects of your camera and buttons to control pan, tilt, zoom, and focus. Presets can be created and called. You can also change speed settings and open the On-Screen Display (OSD) menu. If applicable, focus can be locked or unlocked through the drop-down menu.

The **Live** section of the Web UI is the first page you will see after entering your credentials. This contains a live feed of the camera that is viewable through Internet Explorer.

The **Video** section of the Web UI allows you to adjust aspects of the video stream(s) available on your camera.

The **Image** section of the Web UI allows you to control: brightness, saturation, hue, contrast, and sharpness. You can also flip the video image on a horizontal and/or vertical axis.

The **Audio** section allows you to adjust the audio features of your camera.

The **System** section allows you to define new login credentials for your camera, and reboot the camera.

The **Network** section is where you can change the network settings of your camera and enter RTMP MRL(s).

The **Information** section shows identifiers for the camera.



## Find Software to Get Started

PTZOptics provides a wide range of software to help you use your camera.

All software is available at:

<http://ptzoptics.com/setup>

### Camera Control App

Take control of your USB-connected camera with the Camera Control App.

### Open Source IP Connection Software

Use our Open Source IP connection software to control your camera and adjust settings.

### IP Address Setting Tool

The IP Address Setting Tool finds your camera on the network. It is also the tool, which you will use to upgrade your camera's firmware.

### OBS Plugin

Do you use OBS Studio? If so, we have a plugin to enable control of our cameras. Try it out!

### iOS App

Control your camera through your iOS device.

### Android App

Control your camera through your Android device.



## User Manual / General Resources

A general online user manual is available at:

<https://ptzoptics.com/user-manual/>

The user manual for your specific camera is available at:

<https://ptzoptics.com/resource-library/>

## Troubleshooting

For all other questions, please reach out to the PTZOptics Support Department at [Support@PTZOptics.com](mailto:Support@PTZOptics.com)

